

LPS

1212, 1512, 2512

Lithium Power Supply



User Manual



Table of Contents

1	About this Manual	1
2	General Safety.....	2
3	Technical Specifications	3
4	Unpacking the LPS.....	5
5	About the LPS.....	5
6	Package Contents.....	7
7	Display.....	8
8	Installing the Connection Set / Preparing Connections	9
9	Mounting	10
10	Installation	11
11	Installation of Accessories.....	13
12	Operation.....	15
13	Displays	20
14	Maintenance.....	21
15	Troubleshooting.....	22
16	Disassembly	25
17	Disposal.....	25
18	EU Declaration of Conformity	25

1 About this Manual

Read this manual carefully and keep it in a safe place. This manual is intended for users with previous knowledge in the automotive electrical field.

Throughout the manual, you will be alerted to warnings and safety notices about potential hazards associated with handling the device. The colours and signal words indicate the severity of the hazard:

Signal word	Meaning
 DANGER	Warns of imminent danger resulting in death or serious injury.
 WARNING	Warns of a potentially dangerous situation that can result in death or serious injury.
 CAUTION	Warns of a potentially dangerous situation that can result in moderate or minor injuries.
NOTICE	Warns of a potentially dangerous situation that can result in material and environmental damage.

In this manual you will find the following symbols:



Shows you useful tips and information about the device.



Indicates a mandatory requirement for the following instruction.



Shows the result of an instruction.

The information in this manual describes the factory settings of the device.

2 General Safety

This manual supports safe handling of the device. Use the device solely in accordance with its intended use:

The LPS is a high-quality product for mobile power supply in vehicles. All components relevant for the power supply of the vehicle are integrated into one device. This means that the LPS performs many functions that are conventionally performed by individual components. The LPS supplies 12-V and 230-V consumers simultaneously via the integrated lithium-ion battery. When the 230-V mains connection is inserted, the LPS is quickly charged via the built-in charger. The connected 230-V consumers are automatically supplied by the mains priority circuit via the 230-V mains.

Solar cells or alternative energy sources can also contribute to energy input. Weak and discharged starter batteries can be supported with the optional jumpstart function (emergency start).

Any modifications to the device or its components are prohibited and do not conform to its intended use.

The LPS is a protection class 1 device. Only connect the LPS to low-voltage sources which have an earth connection (shockproof socket with PE) and a RCD circuit breaker (FI).

Observe the following safety instructions:

- Store and mount the LPS upright, never overhead or on its side.
- Danger from damaged, frozen or deformed batteries: Before charging, make sure that the battery is undamaged and the electrolyte is not frozen.
- Only charge batteries in well-ventilated rooms and away from ignition sources.

3 Technical Specifications

Model	LPS 1212	LPS 1512	LPS 2512
Part number	014-02001GF	014-01004GF	014-03001GF
Device			
Weight (with/without packaging)	26 kg / 28 kg	28 kg / 30 kg	
Dimension (device)	390 mm x 244 mm x 250 mm		
Dimension (packaging)	495 mm x 355 mm x 350 mm		
Protection class	I		
IP rating	IP21		
Operating temperature	-20°C ... +50 °C		
Cooling	Fan, active		
Battery			
Battery type	Lithium iron phosphate (LiFePO4)		
Available capacity	48 Ah (634 Ah)	80 Ah (1056 Ah)	
Rated value	60 Ah (792 Ah)	100 Ah (1320 Ah)	
Cycle stability at 80%	2000 cycles		
AC input			
Voltage / frequency (rated values)	230 V / 50 Hz		
Voltage range	207 V ... 253 V		
Frequency range	45 Hz ... 65 Hz		
Current	2.5 A	3.5 A	
Charging time	95 min		
Connections	Neutrik PowerCon type A		

Model	LPS 1212	LPS 1512	LPS 2512
Part number	014-02001GF	014-01004GF	014-03001GF
AC output			
Voltage / frequency (rated values)	230 V / 50 Hz		
Power (continuously)	1000 W	1300 W	2000 W
Power (mains priority circuit)	1800 W	1800 W	2300 W
Power (< 15 min)	1200 W	1500 W	2500 W
Power (< 10 s)	2400 W	3000 W	5000 W
Connections	Neutrik PowerCon type B, two-pin earthed plug		
DC input			
Voltage (rated value)	12 V		
Voltage range	12.8 V ... 15 V		
Current	25 A	50 A	
Charging time	105 min		
Connection	Anderson SB50, grey		
DC output			
Voltage (rated value)	13.2 V		
Voltage range	9.5 V ... 15 V		
Current (continuous)	60 A		
Current (< 20 min)	70 A		
Current (< 1 min)	100 A		
Current (< 10 s)	150 A		
Connection	Anderson SB50, red		
Performance data / operating periods			
Internal consumption (only DC active)	5 W		
Internal consumption (AC+DC active)	22 W		35 W
Internal consumption (Sleep)	0.025 W		
Operating periods (200 W)	155 min	260 min	250 min
Operating periods (500 W)	65 min	110 min	105 min
Operating periods (1000 W)	35 min	55 min	55 min

4 Unpacking the LPS

To unpack the device, perform the following steps:

1. Lift the device out of the transport box using the black carrying handles on the front and back.



The device is unpacked.



After unpacking, check the scope of delivery of the LPS (see page 7).

5 About the LPS



Number	Details
1	On/Off button
2	Display
3	Control panel / navigation buttons
4	Carrying handle (front)
5	Two-pin earthed socket, AC output (230 V)
6	Fuse cap, RCD



Number	Details
7	Carrying handle (back)
8	D-Sub plug for communications connections
9	AC output (230 V) Neutrik, grey
10	AC input (230 V), Neutrik, blue
11	DC output, (12 V) Anderson, red
12	DC input, (12 V) Anderson, grey

6 Package Contents

Figure	No.	Part Name
	x 1	Lithium Power Supply (LPS)
	x 1	D-Sub data adapter
	x 1	Anderson plug SB50, red
	x 1	Anderson plug SB50, grey
	x 4	Contacts for Anderson SB50 plugs
	x 4	4 x M3 screws for fastening the Anderson plugs
	x 1	Neutrik PowerCon type A plug, blue
	x 1	Neutrik PowerCon type B plug, grey
	x 1	Mains cable, Neutrik PowerCon type A with two-pin earthed plug

7 Display

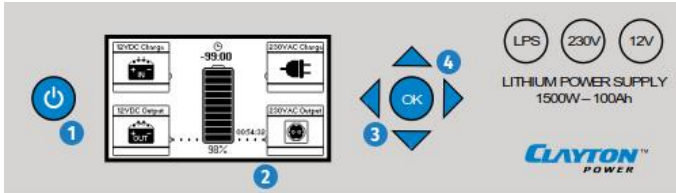

Number	Item
1	On/Off button
2	Display
3	Arrow button
4	OK button

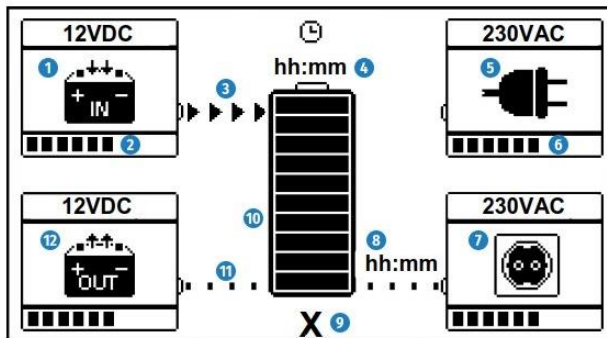

No.	Item
1	DC input (12 V)
2	Shows the charging capacity in 10 % increments
3	Shows the direction of the current flow
4	Shows the remaining operation (-hh:mm) or charging time (hh:mm)
5	AC input (230 V)
6	Shows the discharging capacity in 10 % increments
7	AC output (230 V)
8	Shows the remaining time until the output switches to Energy Saver
9	Shows the charge status of the battery in percent
10	Shows the charge status of the battery in 10 % increments
11	Shows the standby mode of the connection
12	DC output (12 V)

8 Installing the Connection Set / Preparing Connections

Anderson Plug

To mount the Anderson plug, observe the following notes:



For installation you need a H07V-K or equivalent electrical cable with a cross-section of 16 mm² and a crimping tool.

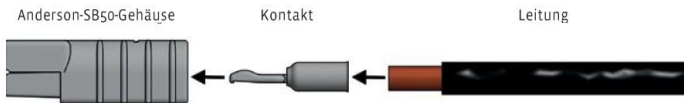

Grey Anderson plug for DC input (12 V).
Red Anderson plug for DC output (12 V).

Notice: Reverse polarity may damage the device. Pay attention to the polarity of the wires. The housing is marked with plus and minus.



Loosen and pull out incorrectly inserted cores using gentle lever movements from a screwdriver (slot).

Mounting Neutrik Plug

To mount the Neutrik plug, observe the following notes:



For installation you need a H07RN-F 3G or equivalent electrical cable with a cross-section of 1.5 mm².

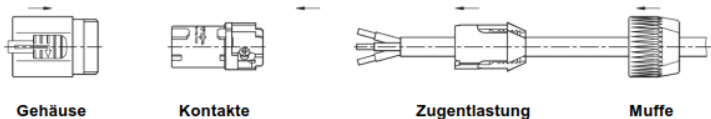

Gehäuse

Kontakte

Zugentlastung

Muffe



- blue Neutrik plug for AC input (230 V)
- grey Neutrik plug for AC output (230 V)
- white strain relief for cables with an average cross-section of 6 mm ... 11 mm
- black strain relief for cables with an average cross-section of 9.5 mm ... 15 mm

Mounting the D-Sub Data Adapter

To mount the D-Sub data adapter, observe the following instructions:



You need an H07V-K or equivalent electrical cable with a cross-section of 1 mm² and, if necessary, a fuse holder.

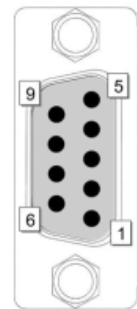

Pin	Item	Use
1	Single wire	Data transmission
2	CAN-Low	Software update
3	GND	Ground connection for accessories
4	+12 V*	+12 V (active, if LPS active)
5	Input 2	External switching signal (switching the inverter)
6	Output 1	CDR connection (jumpstart function)
7	CAN-High	Software update
8	Output 2	Signal output**
9	Input 1	Activation of DC input after 10 s connection D+ signal (terminal 15/terminal 61)***

* From hardware 2.02 (up to hardware 2.01: GND (ground))

** can be parametrised accordingly

*** Allocation necessary for installation at DC input

9 Mounting

To mount the device, perform the following steps:

NOTICE

- Choose a cool, dry and well-ventilated mounting site.
- Mount the device on a flat surface.
- Do not mount the device directly next to or above batteries or any flammable materials

1. Fasten the device to the mounting location with screws on the underside of the device or with the LPS mounting plate (optional accessory).



The device is mounted.

10 Installation



Ensure that the LPS is switched off during installation.

Connecting the AC Input (230 V)

To install the device to the 230-V mains, perform the following steps:

1. Insert the blue Neutrik plug of the mains cable into the AC input (230 V) on the device.
2. Turn the Neutrik plug clockwise until it clicks into place.
3. Plug the two-pin earthed plug into a 230-V mains supply.



The LPS starts the charging process automatically, consumers at the AC output (230 V) are supplied with power via the 230-V mains (mains priority circuit).



The device is connected.

Connecting the DC Input (12 V)

To connect the LPS to the vehicle battery, perform the following steps:



Grey Anderson plug is mounted.

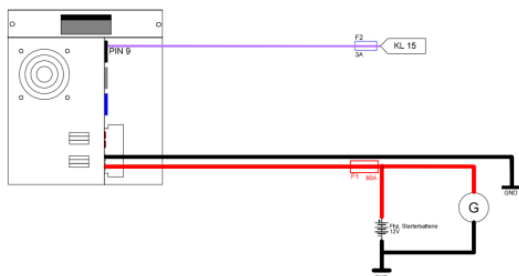

1. Disconnect the battery from the vehicle power circuit.
Warning: Disconnect the negative cable first.
2. Secure the positive cable of the grey Anderson plug as close as possible to the vehicle battery with a suitable fuse (80 A).
3. Connect the positive cable of the grey Anderson plug with the positive terminal of the battery.
4. Connect the negative cable of the grey Anderson plug to the negative terminal of the battery.
5. Connect a signal cable (1 mm²) to terminal 15 (switched ignition plus) or terminal 61 (ignition signal) of the vehicle.

6. Secure the signal cable near the connection to the vehicle with a suitable fuse (1 A ... 3 A).
7. Connect the open end of the signal cable to pin 9 of the D-Sub data adapter.
8. Connect the D-Sub data adapter to the D-Sub plug on the device.
9. Plug the grey Anderson plug into the DC input (12 V) on the device and screw it tight.
10. Connect the vehicle battery with the vehicle power circuit.



The device is connected.

Connecting the Consumer AC Output (230 V)

You have two options for connecting consumers to the AC output (230 V).

- Consumer with Neutrik plug:
Insert consumer with Neutrik plug into the AC output on the back of the device.



A Neutrik plug is included. You will find information on how to install the plug on page 9.

- Consumer with two-pin earthed plug:
Plug consumer with two-pin earthed plug into the AC output on the front of the device.



The consumer is connected.

Connecting the Consumer DC Output (12 V)

To connect consumers to the DC output (12 V), perform the following steps:

1. Insert the red Anderson plug of the consumer into the DC output of the device.



An Anderson plug is included. You will find information on how to install the plug on page 9.



The consumer is connected.

11 Installation of Accessories

Connecting Solar Panel

To charge the LPS with solar panels, perform the following steps:



- You need a solar charge controller with Maximum Power Point Tracking (MPPT) and an output voltage (DC) of 14.5 V ... 15 V.
- You have mounted the red Anderson plug.

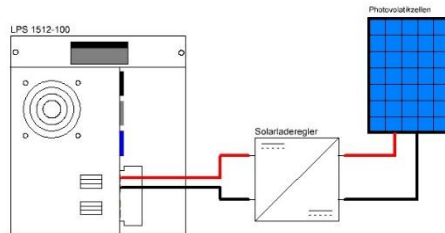

1. Connect the solar controller with the red Anderson plug.
2. Connect the solar charge controller to the photovoltaic cells.



For the installation of the solar charge controller, follow the notes and instructions in the device manual.

3. Insert the red Anderson plug into the DC output (12 V).
4. Activate the DC output (12 V) via the menu of the LPS (see page 18).



The solar panel is connected.

Connecting Fuel Cells

To charge the LPS using alternative charging sources (fuel cells), perform the following steps:



You have mounted the red Anderson plug.

1. Connect the fuel cell with the red Anderson plug.



For the installation of the fuel cell, follow the notes and instructions in the device manual.

2. Insert the red Anderson plug into the DC output (12 V).
3. Activate the DC output (12 V) via the menu of the LPS (see page 18).



The fuel cell is connected.

Connecting the CDR Power Distributor Relay

The LPS has a jumpstart function to start the vehicle when the starter battery is discharged. In an emergency, the CDR power distributor relay ensures controlled and current-limited charge compensation between the LPS and the empty starter battery.



From hardware version 12.20/15.20/25.20, the jumpstart function is also possible without CDR.

To connect the CDR power distributor relay, perform the following steps:



- You need a CDR 200/40.
- You need two cables (16 mm²).

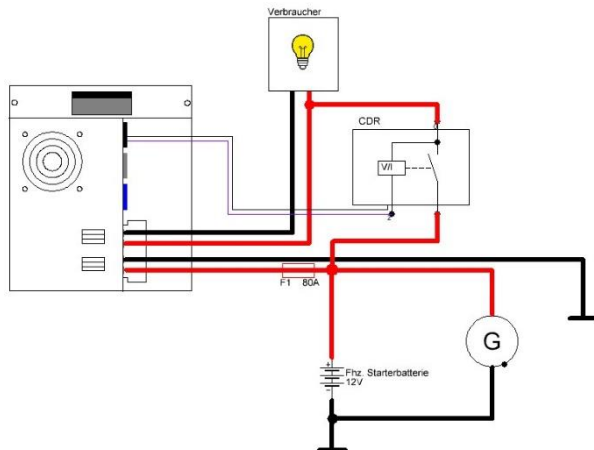

1. Disconnect the starter battery from the on-board power supply.
Warning: Disconnect the negative lead first.
2. Secure one cable (16 mm²) of the device near the vehicle battery with a suitable fuse (80 A).
3. Using the fused line, connect the positive terminal of the vehicle battery to a screw terminal of the CDR.
4. Use a cable to connect the same screw terminal of the CDR with the positive contact of the grey Anderson plug.
5. Use a cable to connect the negative terminal of the vehicle battery to the negative contact of the grey Anderson plug.

6. Use a cable to connect the other screw terminal of the CDR to the positive contact of the red Anderson plug.
7. Connect the ground wire (black) and bridging wire (blue) of the CDR to pin 6 of the D-Sub data adapter.
8. Insert the D-Sub data adapter into the D-Sub plug of the LPS.
9. Insert the grey Anderson plug into the DC input (12 V) and screw the Anderson plug tight.
10. Insert the red Anderson plug into the DC output (12 V) and screw the Anderson plug tight.



The CDR is connected.

Connecting the LPS Remote Display

If the LPS is installed such that the display is not visible, an LPS remote display from LEAB can be connected to control the LPS.



To install the remote display, follow the notes and instructions in the manual.

12 Operation

Switching on the LPS

To switch on the LPS, perform the following step:

1. Press the On/Off button to switch on the LPS.
 - The display will light up.



The LPS is switched on.

Charging the LPS (230 V, AC)

To charge the LPS with 230 V, perform the following steps:



- Blue Neutrik plug is mounted.

1. Plug the two-pin earthed plug of the mains cable into a 230-V mains supply.
 - The charging process starts automatically.
 - Display is activated.



The factory-set mains priority circuit supplies the connected 230-V consumers via the 230-V mains.



The LPS is charged.

Limiting Input Current (230 V, AC)

The LPS gives you the option to control the input current of the AC input, adjustable values are between 1 A and 10 A. To limit the input current at the AC input, perform the following steps:



Device is ready for operation.

1. Press the OK button to access the menu.
2. Select the menu item '230VAC Charging' by pressing the arrow buttons (up/down) and confirm selection by pressing the OK button.
3. Select the menu item 'Maximum Current' by pressing the arrow buttons (up/down) and confirm selection by pressing the OK button.
4. Select the desired current limit value by pressing the arrow buttons (up/down) and confirm selection by pressing the OK button.
5. To exit the menu, press the left arrow button twice.



The input current is limited.

Activate/Deactivate 230-V Output

To activate or deactivate the 230-V output, perform the following steps:



Device is ready for operation.

1. Press the On/Off button to open the On/Off menu.
2. Select the menu item 'AC Out' by pressing the arrow buttons (up/down).

The following icons are displayed:

- | | | |
|--|-------------------------------------|----------------------------------|
| | <input checked="" type="checkbox"/> | AC output is active |
| | | Mains priority circuit is active |
| | <input type="checkbox"/> | AC output is inactive |

3. To change the setting, press the OK button.
4. To exit the On/Off menu, press the left arrow button.



The 230-V output is activated or deactivated.

Deactivate/Activate Energy Saver (230 V, DC)

The Energy Saver is used to set a threshold and a time. If the value falls below this threshold, the set time runs down and the AC output (230 V) is automatically deactivated after the time has elapsed.

To activate or deactivate the Energy Saver, perform the following steps:



The device is switched on.

1. Press the OK button to access the menu.
2. Select the menu item '230VAC Output' by pressing the arrow buttons (up/down) and confirm selection by pressing the OK button.
3. Select the menu item 'Energy Saver (Threshold)' by pressing the arrow buttons (up/down) and confirm selection by pressing the OK button.
4. In order to activate the Energy Saver, select a value between 0 W and 200 W by pressing the arrow buttons (up/down) and confirm selection by pressing the OK button.
5. To exit the menu, press the left arrow button.
6. Select the menu item 'Energy Saver (No Load)' by pressing the arrow buttons (up/down) and confirm selection by pressing the OK button.
7. In order to activate the Energy Saver, select a time between 1 min ... 10 h by pressing the arrow buttons (up/down) and confirm selection by pressing the OK button.
8. To deactivate the Energy Saver, press the down arrow button until 'inactive' is displayed and confirm the selection with the OK button.
9. To exit the menu, press the left arrow button twice.



The Energy Saver is activated or deactivated.

Charging the LPS (12 V, DC)

The LPS is automatically charged with 12 V when a voltage is applied to the DC input and a signal is applied to the D-Sub connector.



If there is no signal at the D-Sub connector or no voltage, the LPS is not charged.

Activate/Deactivate 12-V Output

To activate or deactivate the 12-V output, perform the following steps:



Device is ready for operation.

1. Press the On/Off button to open the On/Off menu.
2. Select the menu item 'DC Out' by pressing the arrow buttons (up/down).



DC output is active



DC output is inactive

3. To change the setting, press the OK button.
4. To exit the menu, press the left arrow button.



The 12-V output is activated or deactivated.

Activate Jumpstart Function (Emergency Start) (12 V, DC)

With the help of the jumpstart function (emergency start), a discharged starter battery can be jumpstarted by the LPS to such an extent that a starting process is possible again.

To activate the jumpstart function, perform the following steps:



The device is switched on.

A CDR was installed (before HW version 12.20/15.20/25.20 , s. page 14)

1. Press the OK button to access the menu.
2. Select the menu item '12VDC Output' by pressing the arrow buttons (up/down) and confirm selection by pressing the OK button.
3. Select the menu item 'Jumpstart' by pressing the arrow buttons (up/down) and confirm selection by pressing the OK button.
4. To activate the jumpstart function, press the OK button.
 - A charging current of 40 A is provided for 5 min at the DC input.
 - After 5 minutes, the vehicle can be started as usual.
5. To exit the menu, press the left arrow button twice.



The jumpstart function is activated.

Deactivate/Activate Shutdown Delay (12 V, DC)

With the shutdown delay you have the option to delay the deactivation of the DC output until after switching off the LPS.

To activate or deactivate the shutdown delay, perform the following steps:



The device is switched on.

1. Press the OK button to access the menu.
2. Select the menu item '12VDC Output' by pressing the arrow buttons (up/down) and confirm selection by pressing the OK button.
3. Select the menu item 'Shutdown Delay' by pressing the arrow buttons (up/down) and confirm the selection by pressing the OK button.
4. To activate the shutdown delay, select a time of 1 min ... 10 h by pressing the arrow buttons (up/down) and confirm the selection by pressing the OK button.
5. To deactivate the shutdown delay, press the lower arrow button until 'inactive' is displayed and confirm the selection with the OK button.
6. To exit the menu, press the left arrow button twice.



The shutdown delay is activated or deactivated.

Switch Off LPS

To switch off LPS, perform the following steps:

1. Press the On/Off button.
 - An On/Off menu opens.
2. Press the OK button to confirm the 'Shutdown' menu item and switch off the LPS.



The LPS cannot be completely switched off when charging is taking place at the AC input (230 V) or DC input (12 V).



The LPS is switched off.

13 Displays

230 VAC Output

- Operation Status
- Power
- Voltage
- Current
- Energy Saver (No load)
- Energy Saver (Threshold)

230 VAC Charging

- Operation Status
- Power
- Voltage
- Current
- Maximum Current

12 VDC Output

- Operation Status
- Power
- Voltage
- Current
- Jumpstart
- Shutdown Delay

12 VDC Charging

- Operation Status
- Power
- Voltage
- Current

General

- Battery Status
 - Operation Status
 - Remaining Operation
 - Current Capacity
 - Power
 - Voltage
 - Current
 - Temperature
 - Cell 1, 2, 3, 4
- Number of Cycles
- Temperature
 - Transformer Temperature
 - IGBT Module
 - Between Cell 1 and 2
 - Between Cell 2 and 3
 - Between Cell 3 and 4
- Error Codes
- About
 - Serial Number
 - Manufactured
 - Hardware Version
 - Software Version - Unit
 - Software Version - Display

14 Maintenance

Regular Inspection

Check the LPS as follows each time before using it:

- Check the mains cable and mains plug for damage.
- Check charging cables and connections for damage. The LPS must not come into contact with water, oil or other liquids.
- Check the LPS for external damage.
- Check the trip test for the RCD fuse.

Charge the battery at intervals of 3 months via a 230-V mains supply for at least 6 hours.

15 Troubleshooting

Replacing Fuses (DC)

If a fuse is tripped, there is no current flow on the DC side.

A total of 6 vehicle fuses (40 A) are located on the rear of the LPS. The upper 3 fuses protect the DC output, the lower 3 fuses the DC input.

To replace the fuses, perform the following steps:

1. Switch off the LPS.
2. Remove the damaged plug-in fuses on the back of the LPS.
3. Insert fuses of the same type and rating into the fuse device.



The fuses have been replaced.

Replacing Fuses (AC)

If a fuse has been tripped, there is no current flow on the AC side. Check that the fuse toggle switches are facing upwards.

The fuses (AC) are located in the fuse box on the front of the LPS. Open the fuse box and push the toggle switch upwards if necessary.

Error Codes

If the LPS detects an error, the LPS displays the error using an error code. The following table lists the error codes and the actions required to resolve the problem.

Error Code	Error Description	Solution
E001, E002	EPROM memory error	Contact your dealer to arrange a service.
E003	Error internal high voltage	Contact your dealer to arrange a service.
E004, E005	Internal electrical system is too cold	Ensure a warmer ambient temperature.
E006, E007	Internal electrical system is too hot	Ensure a cooler ambient temperature.
E008, E009	Temperature sensor is defective	Contact your dealer to arrange a service.
E010	Calculated efficiency is too low	Contact your dealer to arrange a service.

Error Code	Error Description	Solution
E020, E021	Error in inverter	Perform a restart. If the error has not been corrected, contact your dealer to arrange a service.
E022	Error in charger	Perform a restart. If the error has not been corrected, contact your dealer to arrange a service.
E030, E040	No calibration	Contact your dealer to arrange a service.
E049	Communication error at input and output (DC)	Contact your dealer to arrange a service.
E050	Cell voltage measurement error	Contact your dealer to arrange a service.
E051	Battery empty	Recharge the LPS.
E052, E053	Cell voltage is too low	Recharge the LPS.
E054, E055	Cell voltage is too high	Stop charging the LPS so that the cells equalise. Contact your dealer if the warning is still displayed after 24 hours.
E056, E057	Cell temperature is too low	Ensure a warmer ambient temperature.
E058, E059	Cell temperature is too high	Ensure a cooler ambient temperature.
E060	Battery voltage too low	Recharge the LPS.
E090	Input voltage (DC) is too low	Increase the DC input voltage (12 V).
E091	Input voltage (DC) is too high	Reduce the DC input voltage (12 V).
E092	Input charging current (DC) is too high	Contact your dealer to arrange a service.
E094	Error in output relay make contact (DC)	Contact your dealer to arrange a service.
E095	Error in output relay break contact (DC)	Contact your dealer to arrange a service.
E096	Charging current at output (DC) is too high	Disconnect or regulate the power source at the DC output (12 V).
E097	Discharge current at output (DC) is too high	Disconnect or regulate the power source at the DC output (12 V).
E101	Current measurement error (AC)	Contact your dealer to arrange a service.

Error Code	Error Description	Solution
E102	Current measurement error (DC)	Contact your dealer to arrange a service.
E103	Start error in power supply unit	Perform a restart. If the error has not been corrected, contact your dealer to arrange a service.
E104	Short-circuit in power supply unit	Perform a restart. If the error has not been corrected, contact your dealer to arrange a service.
E105	High-voltage error	Perform a restart. If the error has not been corrected, contact your dealer to arrange a service.
E106	Error in power supply control circuit	Contact your dealer to arrange a service.
E150	Overload at AC output	Reduce the load at AC output (230 V).
E151	Peak current at AC output lasts too long	Reduce the load at AC output (230 V).
E152	Peak current at AC output is too high	Reduce the load at AC output (230 V).
E153, E254	PE/N relay error	Contact your dealer to arrange a service.
E200, E201	Charging current too high	Contact your dealer to arrange a service.
E202	High-voltage error	Perform a restart. If the error has not been corrected, contact your dealer to arrange a service.
E203	Overload at AC output	Contact your dealer to arrange a service.
E204, E205	Error in transfer relay	Contact your dealer to arrange a service.
E206	High voltage Overvoltage	Perform a restart. If the error has not been corrected, contact your dealer to arrange a service.

16 Disassembly

To dismantle the LPS, perform the following steps:

1. Press the On/Off button to open the On/Off menu.
2. Press the OK button to confirm the 'Shutdown' menu item and switch off the LPS.
3. Disconnect the two-pin earthed plug, Neutrik and Anderson connectors as well as the D-Sub data adapter from the LPS.
4. If necessary, loosen the screws for fastening the LPS.



The LPS is now disassembled.

You can transport the LPS using the carrying handles.

17 Disposal

Dispose of the device in accordance with the Battery Act.



The device must not be disposed of with household waste.

Take it to a recycling point or send it to your point of sale.

18 EU Declaration of Conformity

The LPS

with the models **1212, 1512, 2512**

complies with the requirements of the following directives:

2014/30/EC:	EMC
2014/35/EC:	NRL
2011/65/EU:	RoHS



LEAB

LEAB Automotive GmbH

Thorshammer 6

DE-24866 Busdorf



Nr. 317677